

USER MANUAL _166-cell Back Sheet-Glass Framed Module

Model:

120 cells: DD08M.08(II), DD08M(II), DE08M(II), DE08M.08(II),

144 cells: DD17M(II), DE17M(II)

USER MANUAL	1
1. INTRODUCTION FOR USER MANUAL	2
1.1 DISCLAIMER	2
1.2 LIMITATION OF LIABILITY	2
2. SAFETY PRECAUTIONS	2
2.1 WARING	2
2.2 GENERAL SAFETY	2
2.3 HANDLING SAFETY	2
3. UNLOAD/TRANSPORTATION/STORAGE	3
3.1 MAKERS ON OUTER PACKAGING	3
3.2 UNLOADING WARNING	4
3.3 SECONDARY TRANSPORT AND WARNING	5
3.4 STORAGE	6
4. UNPACKING INTRODUCTION	7
4.1 UNPACKING SAFETY	7
4.2 UNPACKING STEP	7
5. SITE SELECTION	8
6. TILT ANGLE	9
7. INSTALLATION	9
7.1 INSTALLATION SAFETY	9
7.2 INSTALLATION METHOD	10
7.2.1 MECHANICAL INSTALLATION AND WARNING	10
7.2.2 GROUNDING	16
7.2.3 ELECTRICAL INSTALLATION	18
8. INVERTER SELECTION AND COMPATIBILITY	20
9. MODULE MAINTENANCE FOR PV MODULE	20
9.1 PANEL VISION INSPECTION AND REPLACEMENT	20
9.2 CONNECTOR AND CABLE INSPECTION	21
9.3 CLEANNING	21
9.3.1 REQUIREMENTS FOR WATER QUALITY	21
9.3.2 MODULE INSPECTION AFTER CLEANING	22
9.3.3 TROUBLESHOOTING 40.....	22
10. REPORTING TECHNICAL ISSUES or CLAIMS	22

1. INTRODUCTION FOR USER MANUAL

This Manual applies to the installation, maintenance and use of the framed series solar modules manufactured by TrinaSolar Ltd. (hereinafter referred to as “Trina Solar”). Failure to follow these safety instructions could result in personal injury or property damage.

Installation and operation of solar modules require specialized skills, and only professional personnel can engage in the work. Please read the “Safety and Installation Instructions” carefully before using and operating the modules. The installer must inform the end customer (or consumer) of the above matters accordingly.

The term “Module” or “PV Module” in this Manual refers to one or more framed series solar modules. Please keep this Manual for future reference.

1.1 DISCLAIMER

Trina Solar reserves the rights to change this User Manual without prior notice. Failure of the customer to follow the requirements outlined in this Manual during the installation of the module will result in the invalidity of product's limited warranty.

1.2 LIMITATION OF LIABILITY

Trina Solar is not responsible for any form of damage, including but not limited to module operation and system installation error, and personnel injury, hurt, and property loss resulted from failure to follow the instructions in this Manual.

2. SAFETY PRECAUTIONS

2.1 WARNING

Before installing, wiring, operating, or maintaining Trina modules, you should read and understand all safety precautions. Direct current (DC) is generated when the battery surface of the module is exposed to direct sunlight or other light sources, and direct contact with the live parts of the module, such as terminals, may result in death of personnel whether connected to the module or not .

2.2 GENERAL SAFETY

All installation work must comply with the local codes and the relevant international electrical standards.

Trina recommends that PV module installation is conducted by personnel with experience in PV system installation. Operation by personnel who are not familiar with the relevant safety procedures will be very dangerous.

DO NOT allow unauthorized persons to access the installation area or module storage area.

DO NOT install modules with damaged glass or damaged backsheet .

DO NOT disassemble or move any part of the module.

DO NOT artificially focus light on the module.

DO NOT connect or disconnect the module when it is energized or connected with an external power supply

2.3 HANDLING SAFETY

DO NOT stand, walk on or lean on the module directly.



DO NOT damage or scratch the front or backside surfaces of the module.

DO NOT scratch the output cable or bend it with force. The insulation of output cable can break and may result in electricity leakage or shock.

DO NOT use water to extinguish fires of an electrical origin.

DO NOT install or handle modules when they are wet or during periods of high wind. At the installation site, take care to keep modules and in particular their electrical contacts, clean and dry before installation. If connector cables are left in damp conditions then the contacts may corrode. Any module with corroded contacts should not be used.

Please DO NOT loosen or unscrew the PV module bolts. This may lead to a reduction of the module's load rating and potential damage from a fall.

DO NOT drop PV modules or allow objects to fall down on the PV modules.

DO NOT touch the terminal box or the ends of the output cables (connectors) with bare hands under sunlight, regardless of whether the PV module is connected to or disconnected from the system.





Modules should not be shaded by buildings, trees, chimney, etc. at any time of the day.



3. UNLOAD/TRANSPORTATION/STORAGE

Precautions and general safety rules:

- The modules should be stored in the Trina original package before installation. Protect the package from damage. Unpack the modules as per the recommended unpacking procedures. The whole process of unpacking, transport and storing should be handled with care;
- DO NOT stand, climb, walk or jump on unpacked pallets of modules;
- Before installation, ensure that all modules and electrical contacts are clean and dry;
- If the modules are required to be stored temporarily, they should be stored under dry and ventilated conditions;
- Unpacking must be carried out by two or more persons at the same time. It is forbidden to use the wires or junction boxes of the modules to carry the modules. Handling the modules requires two or more people with non-slip gloves; DO NOT handle the modules over-head or stack the modules;
- DO NOT put the modules in a place that is not supported or stable;
- DO NOT allow the modules to come in contact with sharp-pointed objectives to prevent them from scratches, avoiding a direct impact on the safety of modules.

3.1 MAKERS ON OUTER PACKAGING

<p>3.1.1 DO NOT discard the modules at will; special recycling is required</p> 	<p>3.1.2 Modules must be kept dry, not expose to rain or moisture</p> 
<p>3.1.3 Modules in carton are fragile, which must be handled with care</p> 	<p>3.1.4 The packaging must be transported upright</p> 

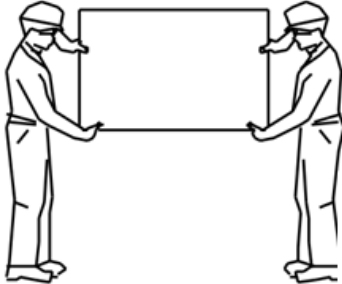
<p>3.1.5 DO NOT step on the package and module</p> 	<p>3.1.6 The carton can be recycled</p> 
<p>3.1.7 Modules shall be stacked as required, not exceeding the maximum number of layers printed on the outer packaging. (n = 2 means no more than two layers and n = 3 means no more than three layers)</p> 	<p>3.1.8 One module shall be handled by at least two persons together</p> 

3.2 UNLOADING WARNING

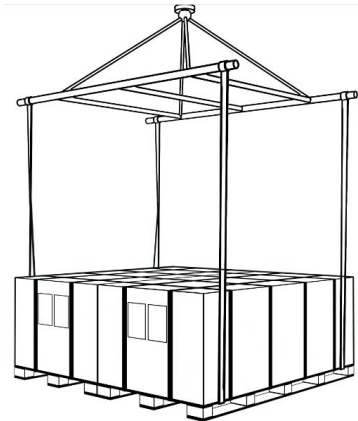
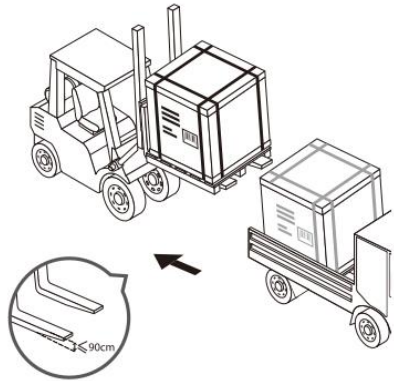
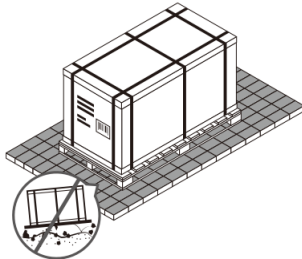
<p>3.2.1 Use the correct (as picture) lifting fixture to handle, no more than 2 pallets per lift. Before lifting, please confirm the tray and the carton are NOT damaged and the hoisting rope is firm and solid. Before lowering the carton back on the ground, two persons must support the two sides of the carton gently to put it on a relatively flat place.</p> 	<p>3.2.2 If the condition permits, use a fork lift to remove the module pallets from the truck</p>  <p>Put the modules on level ground</p> 
--	---

3.2.3 Store the module in a dry and ventilated place

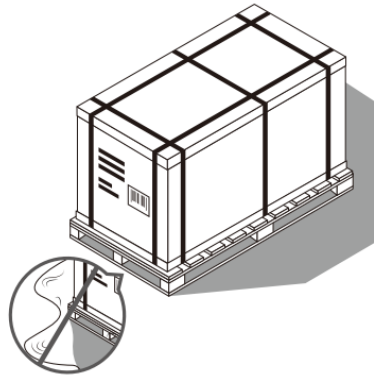

3.2.4 DO NOT stack the modules at the project site.

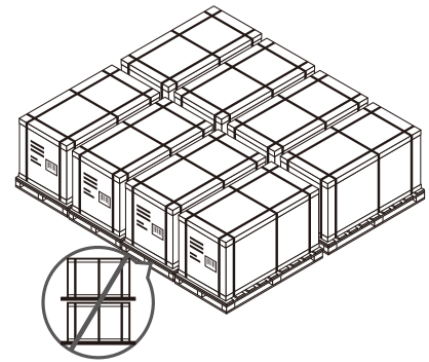

3.2.5 Cover the module with waterproof material to prevent it from moisture



3.3 SECONDARY TRANSPORT AND WARNING

3.3.1 DO NOT remove the original packaging if the modules require long-distance transport or long-term storage.

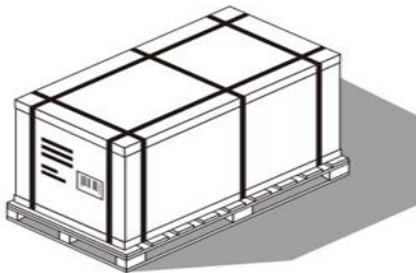

3.3.2 The finished package can be transported by land, sea or air. During transport, make sure that the package is fixed with packing straps securely to the shipping platform without movement.

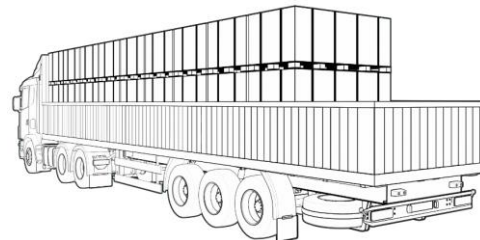

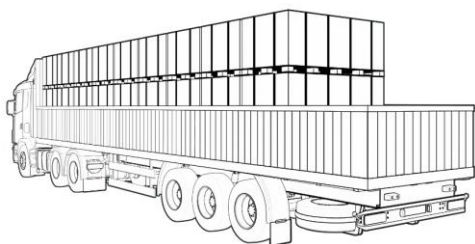

3.3.3 Transport: DO NOT Stack more than two layers on truck;

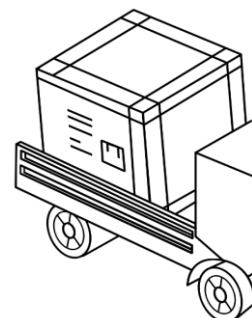

3.3.4 Only one layer stacking is only allowed for small truck. Make sure that the package is fixed with packing straps securely to the shipping platform without movement.

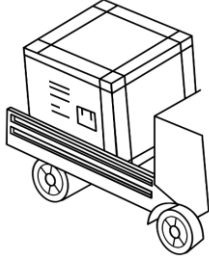
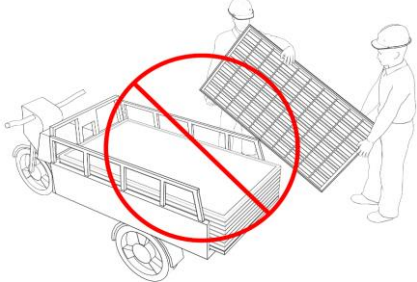
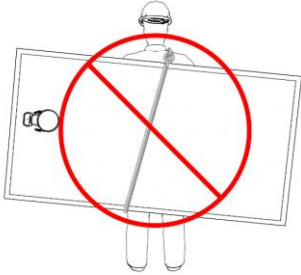

<p>3.3.5 Only one layer stacking is only allowed for transport at the project site</p> 	<p>3.3.6 No transport or handling by pedi-cab as shown below;</p> 
<p>3.3.7 DO NOT transport the module with rope as shown below:</p> 	<p>3.3.8 DO NOT carry the modules on the back of one person as shown below:</p> 

3.4 STORAGE

DO NOT expose the modules to rain or moisture. Store the finished product in a well ventilated, waterproof and dry place.

DO NOT remove the original packaging if the module requires long-distance transport or long-term storage.

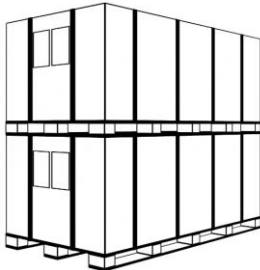
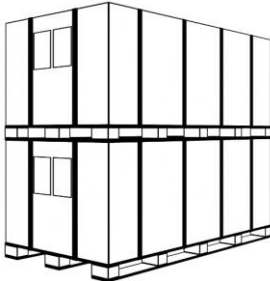
<p>3.4.1 Storage in project site warehouse (moisture < 85%, temperature range from -20°C to + 50 °C): 120-cell frame module and 144-cell frame module to be stacked separately in two groups</p> 
<p>3.4.2 Normal warehouse storage (moisture < 85% and temperature range from -20°C to + 50 °C): 120-cell frame module and 144-cell frame module : stacking no more than two layers</p> 

4. UNPACKING INTRODUCTION

4.1 UNPACKING SAFETY :

For unpacking outdoors, it is prohibited to operate in rainy conditions. Because the carton will become soft and damaged after it gets wet in the rain. The stacked PV modules (hereinafter referred to as "modules") may tip over, which may cause damage or injury to personnel.

For a windy site, it is necessary to pay special attention to safety. Especially, it is NOT recommended to transport the modules in high wind conditions. The unpacked modules must be tied down to avoid any unwanted movement.

The work surface is required to be level to ensure that the package can be placed stably, avoiding sliding.

Wear protective gloves during unpacking to avoid hand injury and fingerprints on the glass surface.

Module information and unpacking instructions can be found on the outside of each package. Please read the instructions before unpacking.

Each module shall be handled by two persons. It is forbidden to use the wires or junction boxes of the modules to carry the module. DO NOT take the module out of the carton by pulling on the long side frame.

4.2 UNPACKING STEP :

4.2.1 Before unpacking, please check the product name, serial number and related suggestions on the A4 paper. Please read the unpacking instructions carefully. NO other customized unpacking method is allowed.

Unpacking instructions

A4 paper (product name, serial number, related suggestions, etc.)

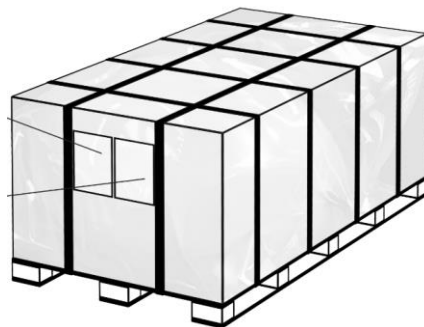

4.2.2 Cut the two packing belts at shorter sides of the tray with blade or scissors, and unpack the side surface of the carton along the vertical direction.

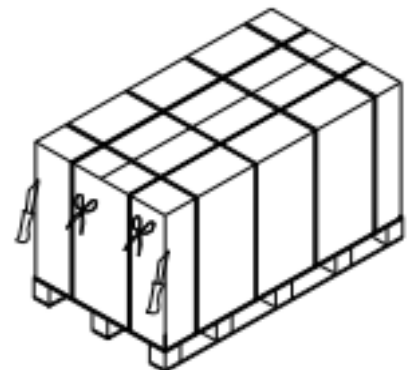

4.2.3 Cut the tape at shorter edge and hold it up by 90° from the bottom; and pull out the cardboard to expose the modules.

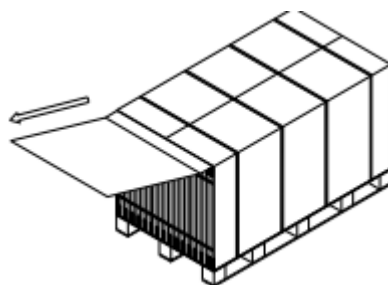

4.2.4 Cut the two horizontal packing belts in the carton and cut the two packing belts near the bottom of the tray, and remove the packing belts

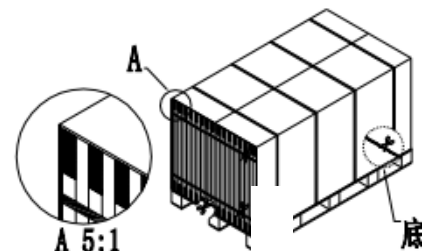

4.2.5 When unpacking on a level surface, take out the module from one side of package to the other, and then carry it with two persons (Please refer to 3.1.8)

When unpacking on a sloping surface, please protect the modules from tipping over or sliding. As shown below.

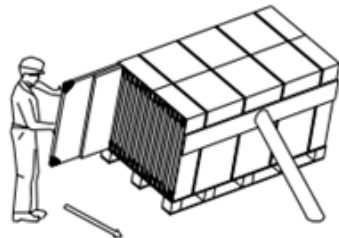

4.2.6 DO NOT lean the module on the mounting posts;



4.2.7 If all the modules are NOT removed after unpacking and some of them are left in the package, the remaining modules shall be laid flat and repackaged to prevent from falling down. Must be placed by horizontal.

The stacked number of modules: 120-cell frame modules to be stacked NOT more than 20 pieces, 144-cell frame modules NOT more than 16 pieces;

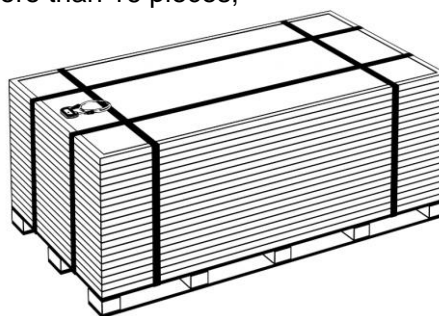

5. SITE SELECTION

Solar modules are recommended to be installed at an optimized tilt angle to maximize the energy output. It is roughly equal to the latitude of the project site as a rule of thumb, facing toward the equator. Optimized system designs incorporate other local requirements.

When installing solar modules on a roof, the roof must be covered with a layer of fireproof material applicable to this class, and adequate ventilation must be ensured between the back sheet and the installation surface. A safe working area also must be left between the edge of the roof and the external edge of the solar array

In the case of residential installations on the ground, modules shall be installed following local regulations, e.g. using fence.

Position the modules to minimize the chances of shading at any time of the day.

Trina Solar recommends that the module should be installed at a working ambient temperature of -20°C ~ 50°C . The module's limit working ambient temperature range is from -40°C to 85°C . Maximum altitude less than or equal to 2000m .The maximum mechanical load is 5400 on the front and 2400 on the back.

Try to install modules in a location where there is rare shading throughout the year

If you are planning to use the PV modules where the water damage (Humidity: $> 85\text{RH}\%$) may be possible, please consult with Trina local technical support first to determine an appropriate installation method , or to determine whether the installation is possible.

If the module is installed in an area with frequent lightning and thunder, the module must be

protected against lightning strikes. Refer to Trina Solar's declaration document for lightning protection. Please contact with local technical support or contact us from <http://www.trinasolar.com/> .

Make sure flammable gases are NOT generated near the installation site.

According to IEC 61701, salt mist corrosion testing of photovoltaic (PV). The module must not be soaked in the water or in the environment (i.e., fountain, spindrift, etc.) where the module would touch water (pure water or brine) for a long term. If the modules are placed in an environment of salt fog (i.e., marine environment) or sulfur (i.e., sulfur sources, volcanoes, etc.), there is a risk of corrosion. PV Modules certified to IEC 61701 available upon request.

In locations that are 50m ~ 500mm from the ocean, stainless steel or aluminum materials must be used to contact the PV modules, and the installation position must be processed with anti-corrosion treatment; refer to the "Trina Solar Coastal Application White Paper" for detailed installation requirements . Please contact with local technical support or contact us from <http://www.trinasolar.com/> .

6. TILT ANGLE

The tilt angle measurement of the PV module refers to measuring the angle between the module and the horizontal ground surface. For different projects there are different mounting angles. Trina Solar recommends that the mounting tilt angle should be NOT less than 10°, or in accordance with local regulations or follow the recommendations of experienced PV module installers.

The tilt angle of the PV module is measured between the PV module and a horizontal ground surface.

In the Northern Hemisphere, the PV modules should typically face south, and in the Southern Hemisphere, the PV modules should typically face north.

A clearance of at least 115mm (4.5in) (recommended) is provided between modules frame and the surface of the wall or roof. If other mounting means are employed this may affect the UL Listing or the fire class ratings.

7. INSTALLATION

7.1 INSTALLATION SAFETY

Always wear dry insulation protection equipment: insulated tools, head gear, insulated gloves, safety belt and safety shoes (with rubber soles).

DO NOT wear metallic jewelry which can cause electric shock during installation.

DO NOT install modules under rain, snow or windy conditions.

Please keep the connector dry and clean during installation to avoid the risk of electric shock. It is recommended to install it immediately after unpacking.

Due to the risk of electrical shock, DO NOT perform any work if the terminals of PV module are wet. Please install immediately after you unpacking.

Our module application class is class C, modules rated for use in this application class may be used in systems operating at greater than 50V DC or 320W, where general contact access is anticipated;

Keep the PV module packed in the Trina carton until installation.

Please use an opaque material to completely cover the PV module surface during PV module installation and wiring.

DO NOT unplug the connector if the system circuit is connected to a load.

DO NOT stand on the module glass while installing. There is a risk of injury or electric shock if glass is broken.

DO NOT work alone (always work as a team of 2 or more people).

DO NOT damage the back sheet of PV modules when fastening the PV modules to a support with bolts.

DO NOT damage the surrounding PV modules or mounting structure when replacing a PV module.

The cable length of junction box shall be selected according to the installation mode. When wiring, the ties for fixing the cables coils shall be removed. The cable shall be fixed on the installation system (frame or bracket, guide rail) with UV resistant cable ties or wire cards to avoid direct sunlight or immersion in water and mechanical damage of the cable, otherwise it may cause accelerated aging of the cable or even leakage and fire.

Modules with different color codes are not recommended to be installed in one block or the same rooftop.

7.2 INSTALLATION METHOD

7.2.1 MECHANICAL INSTALLATION AND WARNING

The connection of the module to the racking system can be created through the mounting holes, with clamps, or an embedded system on the frame. The modules must be installed according to the following examples and recommendations. If a different installation method is desired, please contact Trina Solar customer service or technical support team for consultation. Improperly mounted modules maybe damaged. If alternative mounting method is used and not approved by Trina, the modules will not continue to have a valid warranty.

The minimum distance between two modules is 10mm (0.4in).

Panels must not be subjected to wind or snow loads exceeding the maximum permissible loads, and must not be subjected to excessive forces due to the thermal expansion of the support structures.

The module frame drain holes cannot be blocked in any situation during installation or use.

*Notes :

The design loading of modules have been evaluated by TUV according to IEC61215 with 1.5 times safety factor;The mechanical load bearing is dependent upon the mounting methods used and failure to follow the instructions of this manual may result in different capabilities to withstand snow and wind loads;The system installer must ensure that the installation methods used meet these requirements and any local codes and regulations.

The modules depicted are mounted on continuous rails that extend beneath the modules. If modules are mounted without continuous rails below them, the maximum allowable loading will be reduced and is subject to review by Trina.

A. Mounting with Bolts(4- ϕ 9*14mm mounting holes)

Modules can be attached using the mounting holes on the back of the module frame, by fixing the module to the support rails with bolts. The mounting details are shown in the following figures.

The frame of each module has 4- ϕ 9*14mm mounting holes, ideally placed to optimize the load handling capability, to secure the modules to the supporting structure. Installation holes of 4- ϕ 9*14 mm are used for routine installation, as shown in Figure 1 ,

To maximize mounting longevity, Trina Solar strongly recommends the use of corrosion proof (stainless steel) attachment hardware.

Secure the module in each mounting location with an M8 bolt and flat washer, spring washer and nut and tighten to a torque of 16~20 N.m(140-180lbf.in.).

All parts in contact with the modules should use flat stainless steel washers of minimum 1.5mm thickness with an outer diameter of 20-24mm (0.79-0.94in).

Fig.1 Backsheet-Glass module

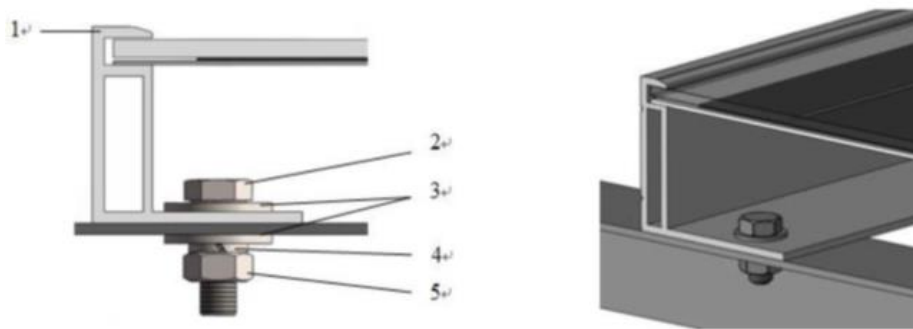

- 1) Aluminum Frame
- 2) M8 Stainless Bolt
- 3) Flat Stainless Washer
- 4) Spring Stainless Washer
- 5) HEX Stainless Nut

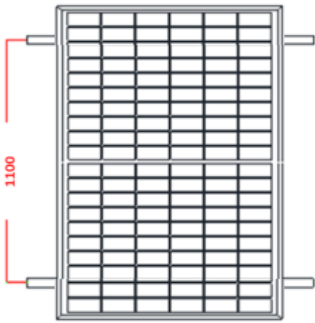
Module	Mechanical Load Pressure	Safety Factor	Mounting Direction(The crossbeam is perpendicular to the long side frame)
<p>120 pcs Back sheet-Glass Framed Module</p>	<p>+3600 Pa /- 1600Pa</p>	<p>1.5</p>	 <p>*NOTE: The above-described distance is from the middle of the bolts to the middle of the bolts *NOTE: Need two support rails below the PV module to make sure the Mechanical load. *NOTE: The actual load is + 5400Pa/-2400Pa</p>

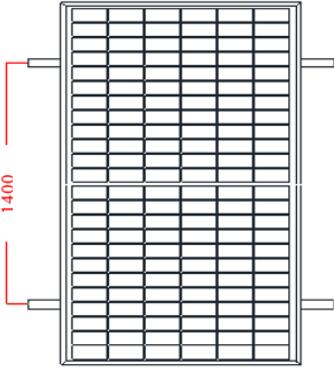
<p>144 pcs Back sheet-Glass Framed Module</p>	<p>+3600 Pa /- 1600Pa</p>	<p>1.5</p>	<div style="text-align: center;">  </div> <p>*NOTE: The above-described distance is from the middle of the bolts to the middle of the bolts *NOTE: Need two support rails below the PV module to make sure the Mechanical load. *NOTE: The actual load is + 5400Pa/-2400Pa</p>
--	---------------------------	------------	--

B. Mounting with Clamps

Trina Solar has tested its modules with a number of clamps from different manufacturers, mounting bolt of at least M8. The length of clamp $\geq 40\text{mm}$ (1.57in) , thickness $\geq 3\text{mm}$ (0.12in).

The clamp must overlap the module frame by at least 7mm (0.28in) but no more than 11mm (0.43 in).

Use at minimum 4 clamps to attach modules to the mounting rails.

Modules clamps should not come into contact with the front glass and must not deform the frame.

Be sure to avoid shadowing effects from the module clamps.

The module frame is not to be modified under any circumstances.

When choosing this type of clamp-mounting method, use at least four clamps on each module, two clamps should be attached on each long sides of the module (for portrait orientation). Depending on local wind and snow loads, additional clamps may be required to ensure that modules can bear the load.

Applied torque should refer to mechanical design standard according to the bolt customer is using, ex: M8 ---- 16-20 N.m(140-180lb.in)

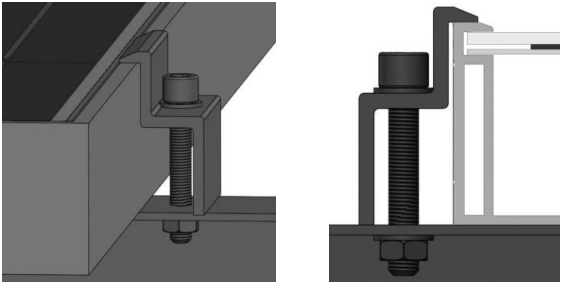
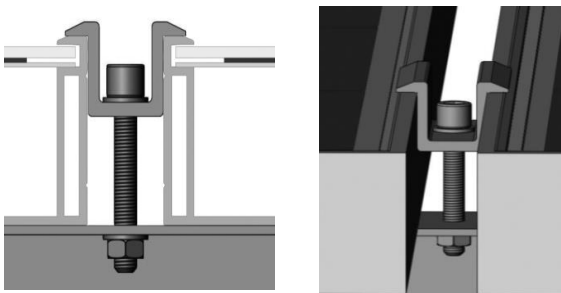
End Clamp installation	Middle Clamp installation
	

Module	Mechanical Load Pressure	Safety Factor	Mounting Direction (The crossbeam is perpendicular to the long side frame)
--------	--------------------------	---------------	--

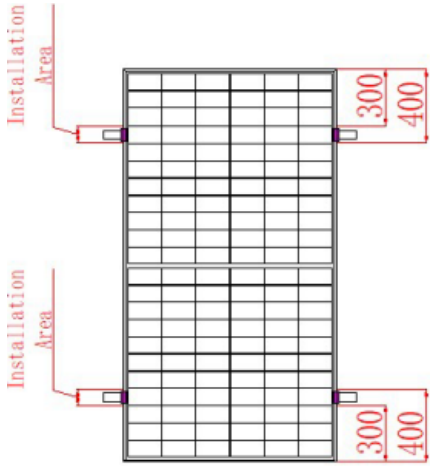
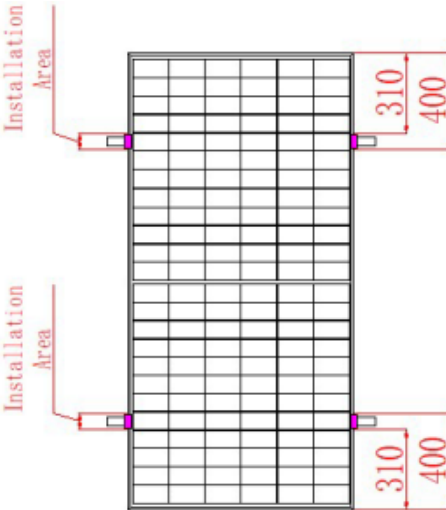
<p>120 pcs Back sheet- Glass Framed Module</p>	<p>+3600 Pa /- 1600Pa</p>	<p>1.5</p>	 <p>*NOTE: The above-described distance is from the module edge to the middle of the clamp *NOTE: Need two support rails below the PV module to make sure the Mechanical load. *NOTE: The actual load is + 5400Pa/-2400Pa</p>
<p>144 pcs Back sheet- Glass Framed Module</p>	<p>+3600 Pa /- 1600 Pa</p>	<p>1.5</p>	 <p>*NOTE: The above-described distance is from the module edge to the middle of the clamp *NOTE: Need two support rails below the PV module to make sure the Mechanical load. *NOTE: The actual load is + 5400Pa/-2400Pa</p>

C. Mounting with Single-axis Tracking System(4-φ7*10mm mounting holes)

Modules can be attached using the mounting holes on the back of the module frame, by fixing the module to the support rails with bolts. The mounting details are shown in the following figures.

The frame of each module has 4-φ7*10mm mounting holes, ideally placed to optimize the load handling capability, to secure the modules to supporting structure. 4 installation holes of φ7*10 mm are used for Single-axis tracking system installation, as shown in Figure 2

To maximize mounting longevity, Trina Solar strongly recommends the use of corrosion proof (stainless steel) attachment hardware.

Secure the module in each mounting location with an M6 bolt and a flat washer, spring washer and nut.

If a different bolt similar to M6 is used, they need to be tightened to a torque of 16N.m.

(140lbf.in).

Flat stainless steel gaskets with a minimum thickness of 1.5mm and an external diameter of 16-20mm (0.63-0.79 inches) shall be used in all parts of the components connected to the Single-axis tracking system.

Mechanical Load Pressure under this method: 30 lbs.ft² max from the front side & 30 lbs.ft² max from the rear according to UL1703.

Fig 2. Backsheet-Glass module with Single-axis Tracing System

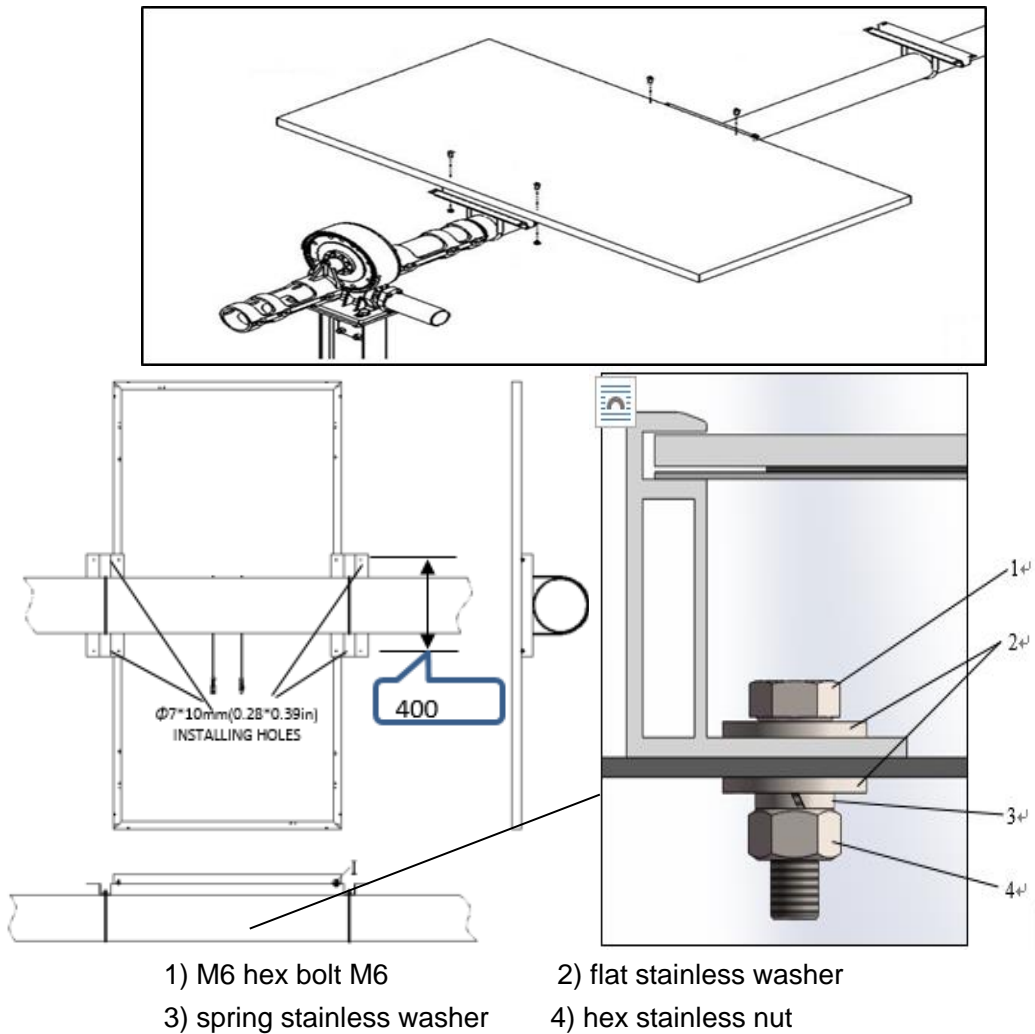

Module	Mechanical Load Pressure	Safety factor	Mounting Direction
--------	--------------------------	---------------	--------------------

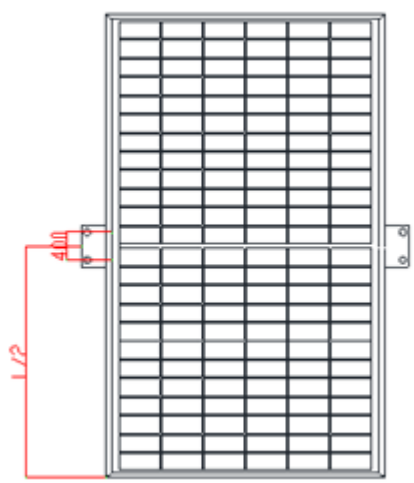
<p>144 pcs Back sheet-Glass Framed Module</p>	<p>+1600 Pa /-1600 Pa</p>	<p>1.5</p>	 <p>*NOTE: The above-described distance is from the middle of the bolts to the middle of the bolts *NOTE: The actual load is + 2400Pa/- 2400Pa</p>
--	---------------------------	------------	---

D. 2V Installation Method

The single module is installed with two $\phi 7*10\text{mm}$ mounting holes and two $\phi 9*14\text{mm}$ mounting holes, as shown in figure 3. The overall installation method is shown in the table below.

Figure: Mounting holes schematic of the single module for the 2V installation method

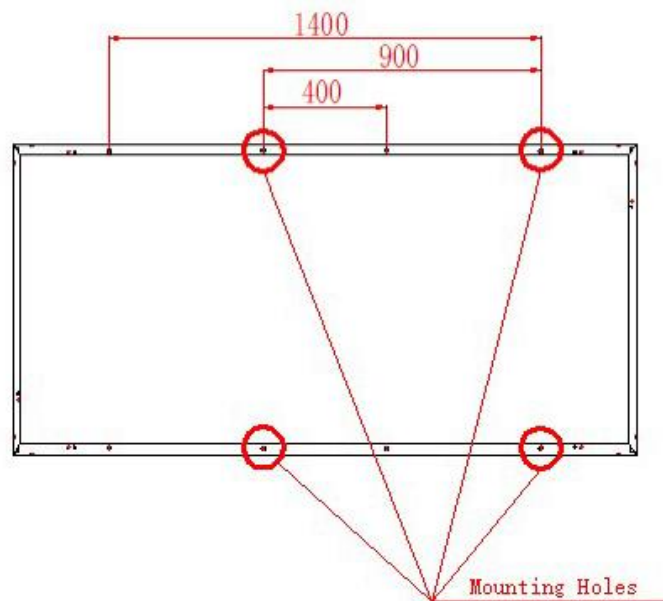

Module	Mechanical Load Pressure	Safety factor	Mounting Direction
--------	--------------------------	---------------	--------------------

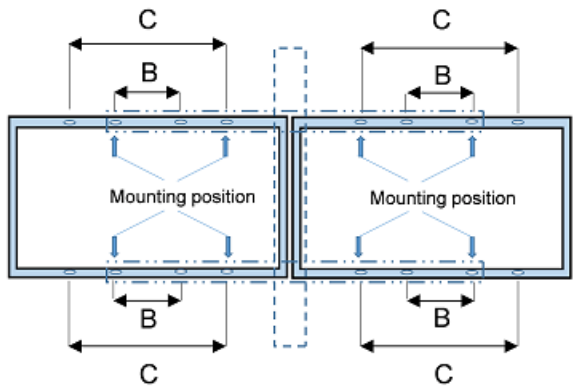
<p>144 pcs Backsheet-Glass</p>	<p>+1066 Pa /-1066 Pa(Special Requirement, need confirm with Trina)</p>	<p>1.5</p>	 <p>*NOTE: Installation hole marked 900 mm pitch is the installation hole of this installation mode. *NOTE: The above-described distance is from the middle of the bolts to the middle of the bolts The actual load is + 1050Pa/-1050Pa</p>
---	---	------------	---

7.2.2 GROUNDING

- All module frames and mounting racks must be properly grounded in accordance with appropriate respective National Electrical Code.
- Proper grounding is achieved by bonding the module frame(s) and all metallic structural members together continuously using a suitable grounding conductor. The grounding conductor or strap may be copper, copper alloy, or any other material acceptable for use as an electrical conductor per respective National Electrical Codes. The grounding conductor must then make a connection to earth using a suitable earth ground electrode.
- Trina Solar modules can be installed with the use of third party listed grounding devices for grounding the metallic frames of PV modules. The devices have to be installed in accordance with the grounding device manufacturer’s specified instructions.
- Please refer to the “Product Catalogue” link for detailed grounding hole locations and size at <http://www.trinasolar.com/>
- Grounding hardware comes in a package that includes the grounding screw, flat washer, star washer and wire
- Electrical contact is made by penetrating the anodized coating of the aluminum frame, and tightening the mounting screw (come with the star washer) to the proper torque of 25lbf.in.
- Grounding wire size (6 to 12 AWG solid bare copper) should be selected and installed underneath the wire binding bolt.

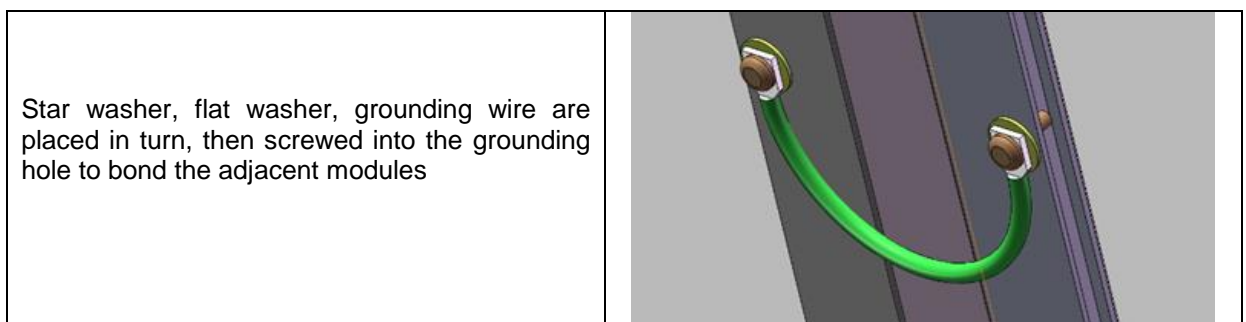

- Trina recommends using the following methods to ground modules properly under UL investigation

Method 1: Tyco grounding bolt # 2058729-1:

Figure 4. Tyco grounding bolt # 2058729-1

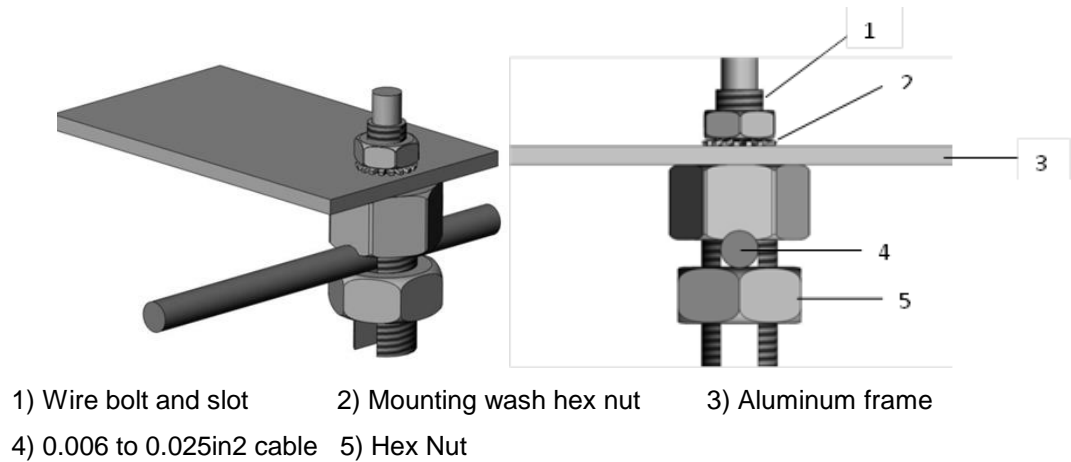

- Tyco grounding hardware comes in a package that includes the grounding bolt, mounting and grounding hex nut.
- Electrical contact is made by penetrating the anodized coating of the aluminum frame, and tightening the mounting hex nut (come with the star washer) to the proper torque of 25lbf.in.
- Grounding wire size (6 to 12 AWG solid bare copper) should be selected and installed underneath the wire binding bolt.
- The wire binding bolt should be tightened to the proper torque of 45lbf.in.

Method 2: Tyco grounding bolt #1954381-2:

Figure 5. Tyco grounding bolt # 1954381-2 (NOT applicable for TRINAMOUNT module series)

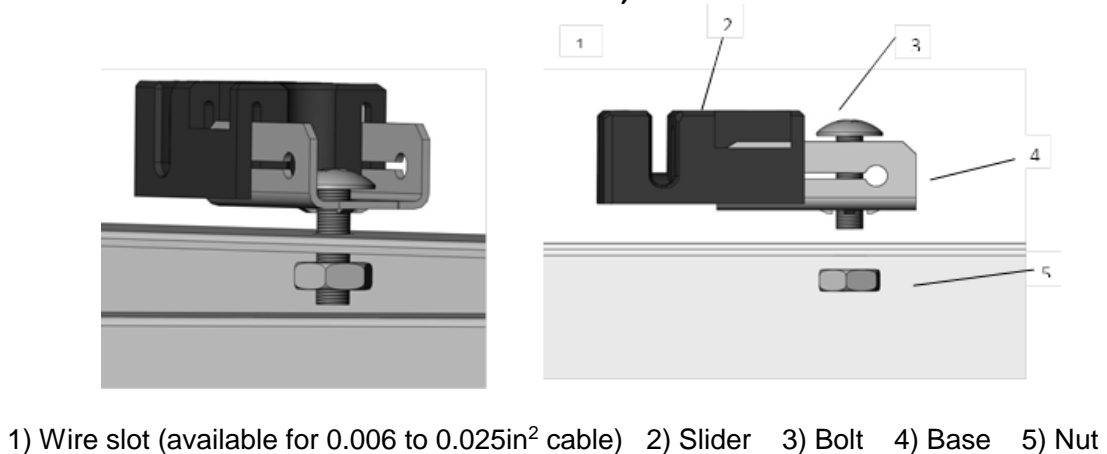

Tyco grounding hardware comes in a package that includes the grounding bolt, mounting and

grounding hex nut.

Electrical contact is made by penetrating the anodized coating of the aluminum frame, and tightening the mounting hex nut (come with the star washer) to the proper torque of 25lbf.in.

Grounding wire size (6 to 12 AWG solid bare copper) should be selected and installed underneath the wire binding bolt.

The wire binding bolt should be tightened to the proper torque of 45lbf.in.

The Tyco grounding bolt is only listed for use with 6 to 12 AWG bare solid copper wire.

Method 3: ERICO grounding bolt # EL6CS14-6

Figure 6. ERICO grounding bolt # EL6CS14-6 (NOT applicable for the TRINAMOUNT module series)

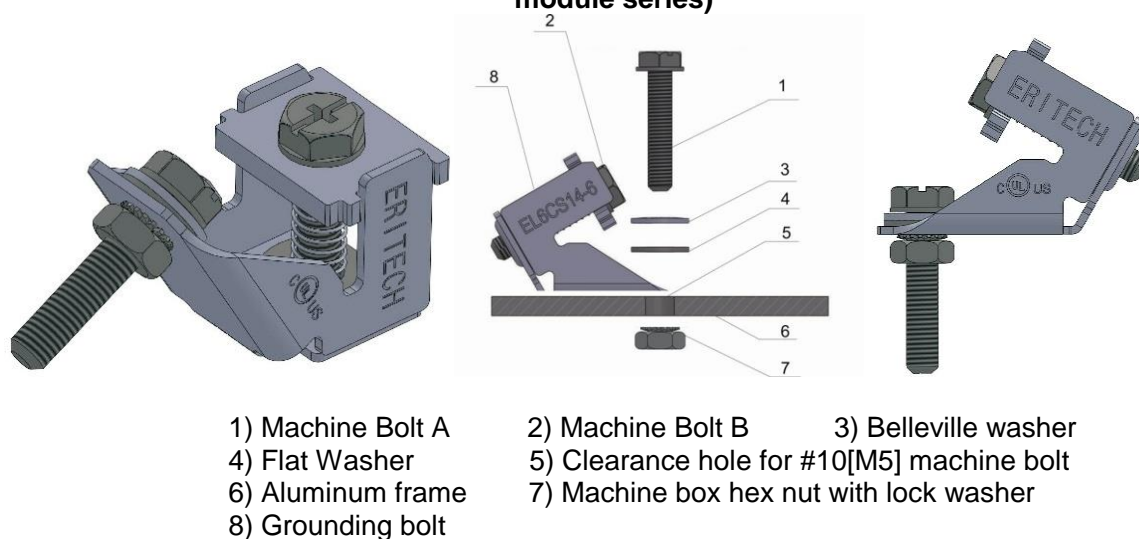

The lug should be installed on a surface that is larger than the bottom surface of the lug.

The lug should be installed in the grounding holes provided on the PV module.

Machine bolt A should be torqued to 35lbf.in, to secure the grounding bolt to module frame.

The grounding bolt is only listed for use with 6-12 AWG bare solid copper wire.

For proper wire binding, machine bolt B should be torqued to 35lbf.in.

7.2.3 ELECTRICAL INSTALLATION

All wiring should be performed, by qualified installers, in accordance with the local codes and regulations.

Modules can be connected in series to increase the operating voltage by plugging the positive plug of one module into the negative socket of the next. Before connecting modules always ensure that the contacts are corrosion free, clean and dry.

Product can be irreparably damaged if an array string is connected in reverse polarity to another. Always verify the voltage and polarity of each individual string before making a parallel connection. If you measure a reversed polarity or a difference of more than 10V between strings then check the string configuration before making the connection.

Trina Solar modules are provided with stranded copper cables with a cross sectional area of 4mm²(0.006in²) which are UV resistant. All other cables used to connect the DC system should have a similar (or better) specification. Trina Solar recommends that all cables are run in appropriate conduits and sited away from areas prone to water collection.

The maximum voltage of the system must be less than the maximum certified voltage and the maximum input voltage of the inverter and of the other electrical devices installed in the system.

To ensure that this is the case, the open circuit voltage of the array string needs to be calculated at the lowest expected ambient temperature for the location. This can be done using the following formula.

$$\text{Max System voltage} \geq N * \text{Voc} * [1 + \text{TCvoc} * (\text{Tmin} - 25)]$$

Where

N Number of modules in series

Voc Open circuit voltage of each module (refer to product label or data sheet)

TCvoc Thermal coefficient of open circuit voltage for the module (refer to data sheet)

Tmin The lowest expected operating temperature of module

Each module has two standards 90°C sunlight resistant output cables each terminated with plug & play connectors. The PV Wire cables are 12AWG in size. This cable is suitable for applications where wiring is exposed to the direct sunlight. We require that all wiring and electrical connections comply with the appropriate National Electrical Code.

The minimum and maximum outer diameters of the cable are 5 to 7mm (0.038 to 0.076in).

For field connections, use at least 4mm² copper wires insulated for a minimum of 90°C and sunlight resistance with insulation designated as PV Wire.

The minimum bending radius cables should be 43mm (1.69in).

7.2.3.1 WIRING

To ensure proper system operation the correct cable connection polarity (Figures 1 & 2) should be observed when connecting the modules to each other or to a load, such as inverter, a battery etc. If modules were not connected correctly, the bypass diode could be destroyed. PV modules can be wired in series to increase voltage. A series connection is made when the wire from the positive terminal of one module is connected to the negative terminal of the next module. Figure 1 shows modules connected in series. PV modules can be connected in parallel to increase current (Figure 2). A parallel connection is made when the wire from the positive terminal of one module is connected to the positive terminal on the next module.

The number of modules in series and in parallel shall be designed reasonably according to the system configuration.

All instructions above have to be obeyed to maintain Trina Solar's limited warranty.

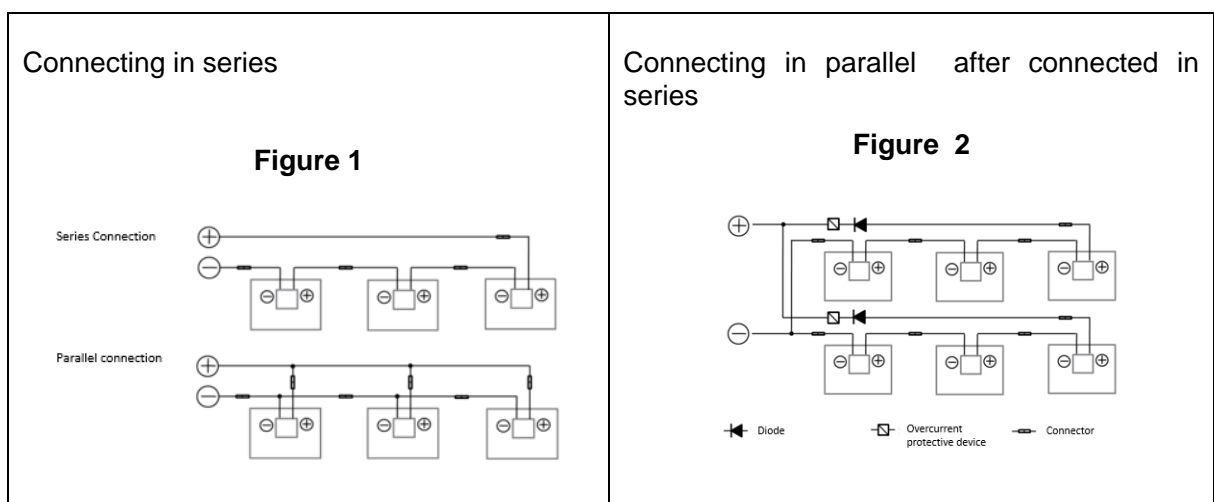

7.2.3.2 FUSING

When fuses are fitted they should be rated for the maximum DC voltage and connected in each, non-grounded pole of the array (i.e. if the system is not grounded then fuses should be connected in both the positive and negative poles).

The maximum rating of a fuse connected in series with an array string is typically 20A but the actual module specific rating can be found on the product label and in the product datasheet.

This fuse rating value also corresponds to the maximum reverse current that a module can

withstand (when one string is shaded then the other parallel strings of modules will be loaded by the shaded string and current will flow) and therefore impacts the number of strings in parallel.

DO NOT share a fuse in a Combiner Box with two or more strings in parallel connection.

8. INVERTER SELECTION AND COMPATIBILITY

When installed in systems governed by IEC regulations, Trina Solar modules normally DO NOT need to be electronically connected to earth and therefore can be operated together with either galvanically isolated (with transformer) and transformerless inverters.

Choose inverters with isolation transformers in hot and wet areas (such as shores, wetlands), to ensure proper module function under positive voltage.

9. MODULE MAINTENANCE FOR PV MODULE

9.1 PANEL VISUAL INSPECTION AND REPLACEMENT

The modules in a PV array should be regularly checked for damage. Factors such as glass breakage, cable breakage, and junction box damage may lead to function and safety problems. In the case of a damaged module, replace it with the same type of module. Refer to the appropriate Product Installation Manual for installation and dis-assembly of module.

It is recommended to perform a preventive inspection every six months without changing the components of the module. If electrical or mechanical appliances are used for inspection or maintenance, they should be operated by qualified professionals to avoid any electric shock or loss of life

Trim any vegetation which may shade the solar array, thus impacting performance.

Check that mounting hardware is properly tightened.

Check that all string fuses in each non/earthed pole are operating.

Replacement modules must be of same type. DO NOT touch live parts of cables and connectors. Use appropriate safety equipment (insulated tools, insulating gloves, etc.) when handling modules.

Cover the front surface of modules by an opaque material when repairing. Modules when exposed to sunlight generate high voltage and are dangerous.

Trina Solar PV modules are equipped with bypass diodes in the junction box. This minimizes module heating and current losses.

- DO NOT open the junction box to change the diodes even if they malfunction.
- In a system using a battery, blocking diodes are typically placed between the battery and the PV module output to prevent battery discharge at night.

In the event that a module is damaged (broken glass or a scratch on back sheet) and needs to be replaced

- Observe the safety precautions listed earlier in this Manual
- Wear cut resistant gloves and other personal protective equipment required for the particular installation.
- Isolate the impacted array string to prevent current flow before attempting to remove the module.
- Disconnect the connectors of the affected module using the related disconnect tool provided by suppliers.
- Replace the damaged module with a new functional module of the same type.
- Check the open circuit voltage of the array string and verify that this is within 10V of the other strings to be connected in parallel.

- Turn the breaker back on.

9.2 CONNECTOR AND CABLE INSPECTION

Inspect all cables to verify that connections are tight; the cables are protected from direct sunlight and sited away from areas of water collection.

It is recommended to check the torque of terminal bolts and the general condition of wiring at least once a year. Also, check that mounting hardware is properly torqued. Loose connections will result in damage to the array.

9.3 CLEANING

The amount of electricity generated by a solar module is proportional to the amount of light falling on it. A module with shaded cells will produce less energy and therefore it is important to keep all PV modules clean.

Clean PV modules when the irradiance is below 200W/m²; liquid with a large temperature difference from the modules must not be used for cleaning the modules;

It is forbidden to clean PV modules under the weather conditions of wind more than 4 grades, heavy rain or heavy snow;

When cleaning with pressurized water, the water pressure on the glass surface of the module must not exceed 700 KPa (14619.80psf); the module must Not bear the extra force;

When cleaning PV modules, DO NOT step on the modules; DO NOT spray water on the backside of the module or the cables; keep the connectors clean and dry; prevent fire and electrical shock from occurring; DO NOT use as steam cleaner;

The back surface of the module normally does not need to be cleaned but, in the event this is deemed necessary, avoid the use of any sharp projects that might damage the penetrating the substrate material.

Periodically trim any vegetation which may shade the solar array thus impacting performance.

When cleaning the modules, use a soft cloth together with a mild detergent and clean water. Take care to avoid severe thermal shocks which might damage the module by cleaning modules with water which has a similar temperature to the modules being cleaned.

Use dry or wet soft clean cloth to clean the PV modules; non-corrosive solvents or hard objects are strictly prohibited;

If there is greasy dirt and other substances on the surface of the PV module which are difficult to clean, conventional household glass cleaning agents can be used; DO NOT use the alkaline and strong acid solvents.

When cleaning the back surface of the module, take care to avoid penetrating the substrate material. Modules that are mounted flat (0° tilt angle) should be cleaned more often, as they will NOT "self-clean" as effectively as modules mounted at a 10° tilt or greater.

If you are unsure whether the array or section there of needs to be cleaned, first select an array string that is particularly soiled, then

Measure & record the inverter feed in current from that string

- Clean all modules in the string
- Measure the inverter feed in current again and calculate the % improvement from cleaning

9.3.1 REQUIREMENTS FOR WATER QUALITY

- PH: 5 ~7;
- Chloride and Salinity: 0 - 3,000 mg/L
- Turbidity: 0-30 NTU
- Conductivity: 1500~3000 μ s/cm
- Total dissolved solids (TDS): \leq 1000 mg/L

- Water Hardness—calcium and magnesium ions: 0-40 mg/L
- Non-alkaline water must be used; demineralized water shall be used if the condition permits.

9.3.2 MODULE INSPECTION AFTER CLEANING

- Ensure that the module under visual inspection is clean, bright and free of stains;
- Spot check to verify whether there is soot deposit on the module surface;
- Check to see there are no visible scratches on the surface of the module;
- Check to see there are no man-made cracks are on the module surface;
- Check to see whether the module support structure is leaning or bent after cleaning;
- Check to see whether the wiring terminals of the module are detached;
- After cleaning PV modules, fill out the PV module cleaning record.

9.3.3 TROUBLESHOOTING

- If your installation does not work properly, please inform your installer immediately. It is recommended to perform a preventive inspection every six months without changing the components of the modules. If electrical or mechanical appliances are used for inspection or maintenance, they should be operated by qualified professionals to avoid any electric shock or loss of life.

10. REPORTING TECHNICAL ISSUES or CLAIMS

- Contact your installer
- Contact Trina Solar after sales service team at <http://customerservice.trinasolar.com/>
- Submit the Customer Feedback form at: <http://www.trinasolar.com/> and one of our technical service representatives will contact you within 5 business days. A username and password is required to send feedback from the customer service link.
- For module specifications or datasheets, please download from: <http://www.trinasolar.com/>